

Side view

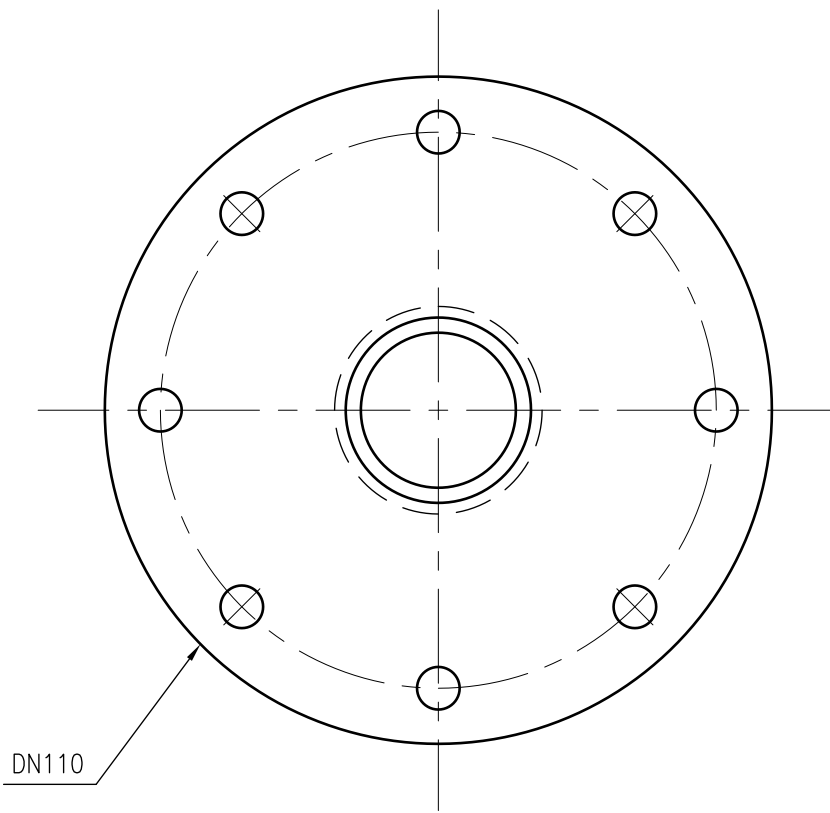

Front view

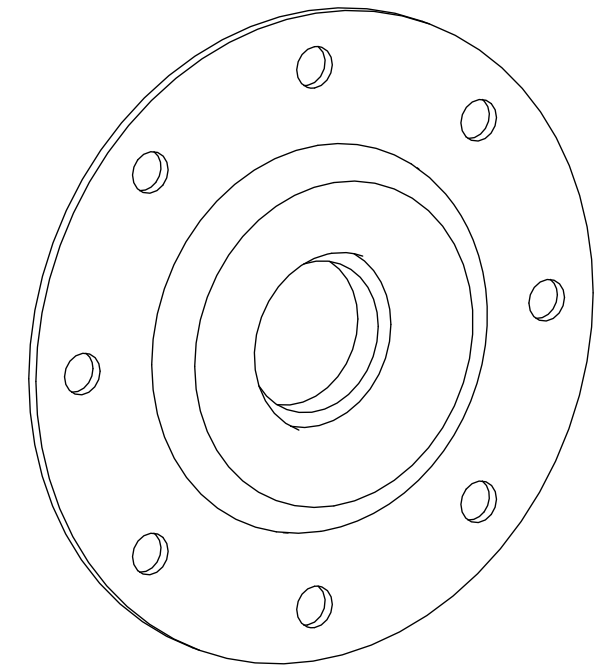

Isometric view



Top view



Unterliegt nicht dem Änderungsdienst/
Not subject to change management

Maßstab/
Scale: 1:2

Format/
Size: A3

Revision
31.03.2021

EEHR Blindflange DN110 – 5418300