

Side view

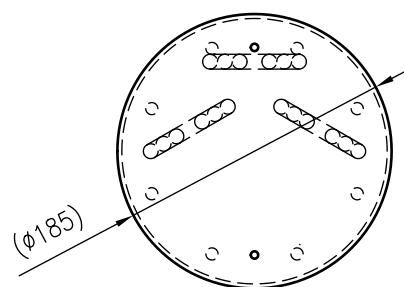

Front view

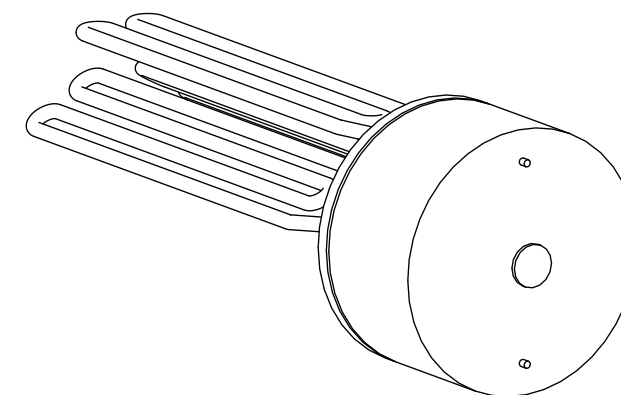

Isometric view

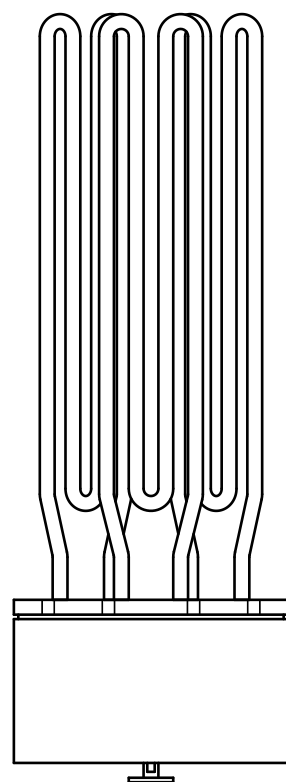

Top view



Unterliegt nicht dem Änderungsdienst/ Not subject to change management		Maßstab/ Scale: 1:5	Format/ Size: A3
Revision 22.06.2016	EFHR 6.0 – 9116315		